









-  Moniteur 17" • Résolution 1280 x 1024
-  Dalle tactile résistive ( P-CAP en option )
-  Entrée vidéo VGA et DVI
-  Interface tactile USB
-  Châssis en inox IP69K
-  Alimentation intégrée 220V AC



Système	
Taille	17 "
Résolution	1280 x 1024
Luminosité	250 cd
Entrée vidéo	VGA & DVI
Connecteur Tactile	USB
Alimentation	Interne 110V/220V AC



I/O	
Vidéo	VGA & DVI
Tactile	USB
Audio	Non

Mécanique	
Construction	Inox
Dimensions	425 x 356 x 90 mm
Poids	7 Kg

**Environnement**

<b>Temp. Fonctionne.</b>	0°C ~ + 60°C
<b>Temp. Stockage</b>	-10°C ~ + 70°C
<b>Humidité</b>	10% ~ 90%
<b>Sécurité</b>	FCC, CE

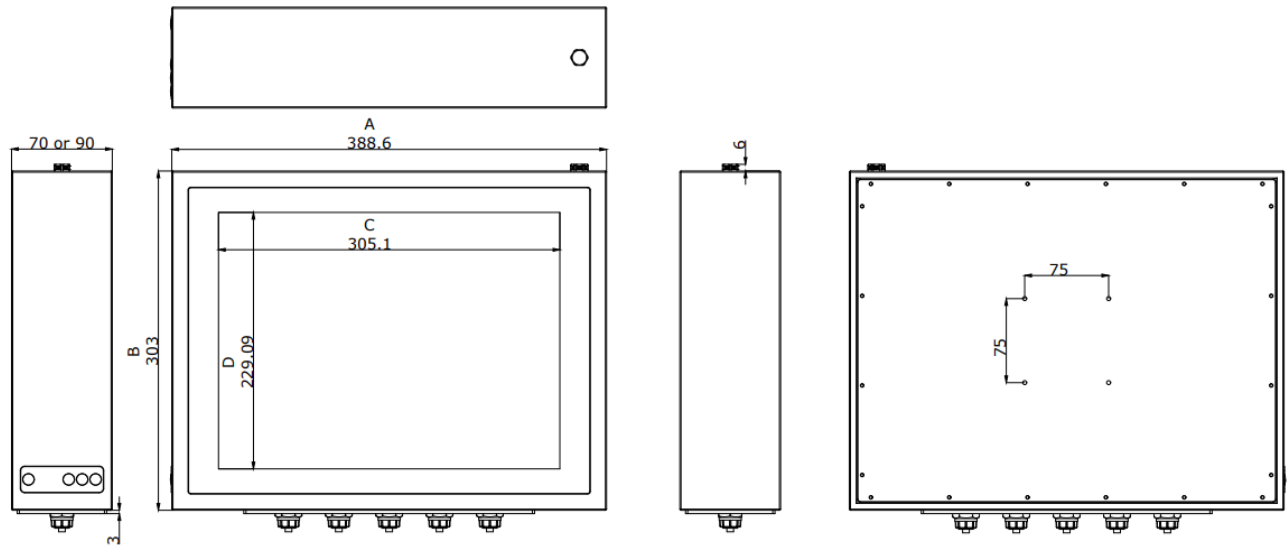

M12 Connector

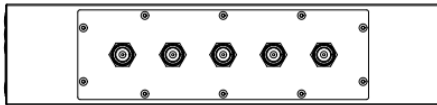

KDL I/O

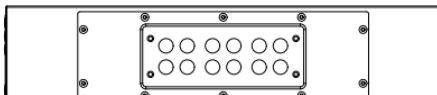

		A	B	C	D
M15I	TCI/TBI/TXI-15	388.60	303.00	305.10	229.09
M17I	TCI/TBI/TXI-17	425.00	356.00	335.00	266.40
M19I	TCI/TBI/TXI-19	463.00	392.00	377.40	302.10

**Options**

<b>Support fixation</b>	Pied / Support VESA 75
<b>Connecteurs IP69</b>	Connecteurs M12 IP69

