



-  Processeur INTEL Bay Trail J1900
-  Ecran 15" 1024 x 768
-  Dalle tactile résistive
-  Solution fanless et étanche IP65 face avant
-  Mémoire DDR3 8G max
-  3 ports RS232 / 3 USB
-  2 ports gigabit Ethernet
-  Alimentation 12V DC / 220V AC



front
IP65

Système	
Chipset	Intel Bay Trail
Processeur	Celeron J1900
Vidéo	INTEL HD
Mémoire	15" rés. 1024 x 768
Expansion	8 GB DDR3 max
Disque dur	2.5" SATA
Port série	3 RS232
Audio	AC97
USB	3 USB
Ethernet	2 Gigabit Ethernet
Alimentation AC/DC	12V DC / 220V AC
TDP	Environ 30 Watts

I/O	
Vidéo	Sortie VGA
USB	3
RS232	3
RJ45	2
Audio	Oui

Mécanique	
Construction	Acier / Inox
Dimensions	379 x 280 x 79 mm
Poids	7 Kg

Environnement

Temp. Fonctionne.	0°C ~ + 50°C
Temp. Stockage	-10°C ~ + 70°C
Humidité	10% ~ 90%
Sécurité	FCC, CE

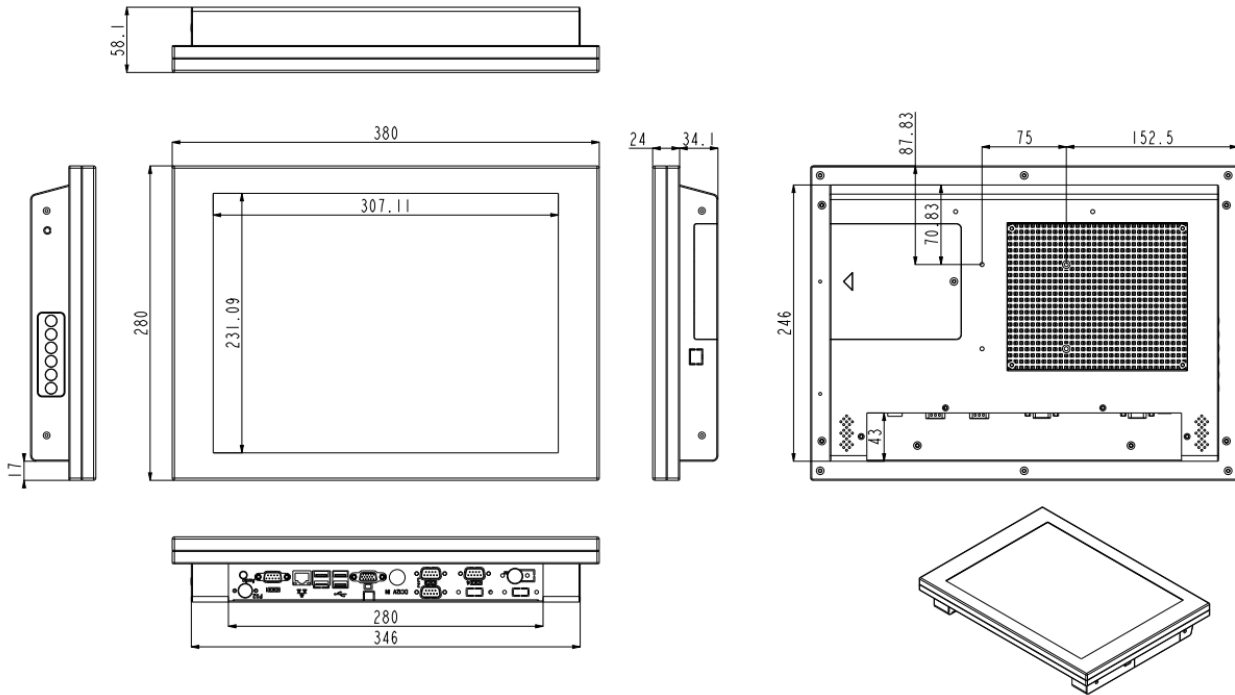
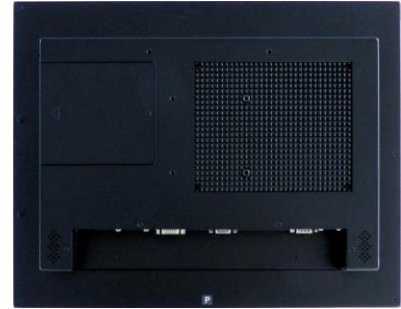

Options

Stockage	SSD
Communications	Wifi / Bluetooth
Support	VESA 75

