











-  Processeur INTEL Bay Trail J1900
-  Ecran 24" • Résolution 1920 x 1080
-  Dalle tactile résistive ou P-CAP
-  Solution fanless et étanche IP69K
-  Mémoire DDR3 8G max
-  2 ports RS232 • 3 USB 2.0
-  2 port gigabit Ethernet
-  Alimentation intégrée



Système	
Chipset	Intel Bay Trail
Processeur	Celeron J1900
Vidéo	INTEL HD
Affichage	24" rés. 1920 x 1080
Mémoire	8 GB DDR3 max
Disque dur	2.5" SATA
Port série	2 RS232
Audio	AC97
USB	3 USB
Ethernet	2 Gigabit Ethernet
Alimentation AC/DC	12V DC / 220V AC
TDP	Environ 30 Watts

I/O	
Vidéo	Sortie HDMI
USB	3
RS232	2
RJ45	2
Audio	Oui

Mécanique	
Construction	Inox
Dimensions	610 x 382 x 90 mm
Poids	12 Kg

**Environnement**

<b>Temp. Fonctionne.</b>	0°C ~ + 50°C
<b>Temp. Stockage</b>	-10°C ~ + 70°C
<b>Humidité</b>	10% ~ 90%
<b>Sécurité</b>	FCC, CE

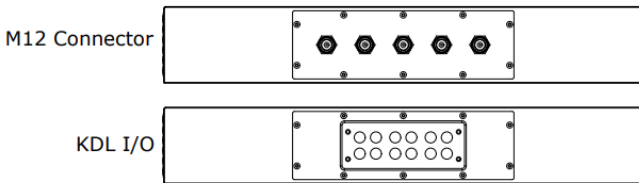
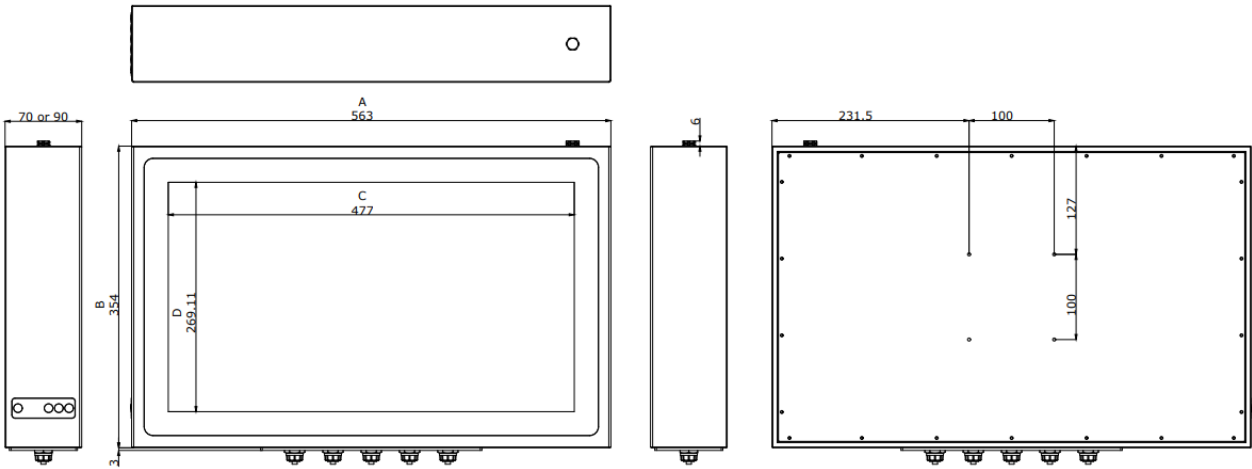

		A	B	C	D	VESA
M185I	TBI/TCI/TXI 185	480.05	305.18	409.96	231.04	750x750
M21I	TBI/TCI/TXI 21	563.00	354.00	477.00	269.11	1000x1000
M24I	TBI/TCI/TXI 24	610.00	382.00	527.04	296.46	1000x1000

**Options**

<b>Stockage</b>	SSD
<b>Communications</b>	Wifi / Bluetooth
<b>Support</b>	VESA 100
<b>Connectique</b>	M12

