











-  Processeur INTEL CORE I3 / I5 / I7
-  Ecran 17" • Résolution 1280 x 1024
-  Dalle tactile P-CAP
-  Solution fanless et étanche IP66 face avant
-  Mémoire DDR4 16 max
-  2 ports RS232 • 4 USB
-  2 ports gigabit Ethernet
-  Alimentation externe 12V DC / 220V AC



**front
IP66**

Système

Chipset	Intel Skylake
Processeur	Core I3-6100U Core I5-6200U Core I7-6500U
Vidéo	INTEL HD
Mémoire	17" rés. 1280 x 1024
Expansion	16GB DDR4 max
Disque dur	2.5" SATA
Port série	6 RS232
Audio	AC97
USB	6 USB
Ethernet	2 Gigabit Ethernet
Alimentation AC/DC	12V~24V DC / 220V AC
TDP	Environ 35 Watts

I/O

Vidéo	Sortie VGA et HDMI
USB	2 USB 2 / 4 USB 3
RS232	6
RJ45	2
Audio	Oui

Mécanique

Construction	Acier
Dimensions	386 x 323 x 84 mm
Dim. découpe	376 x 313 mm
Poids	6 Kg

Environnement

Temp. Fonctionne.	0°C ~ + 50°C
Temp. Stockage	-10°C ~ + 70°C
Humidité	10% ~ 90%
Sécurité	FCC, CE

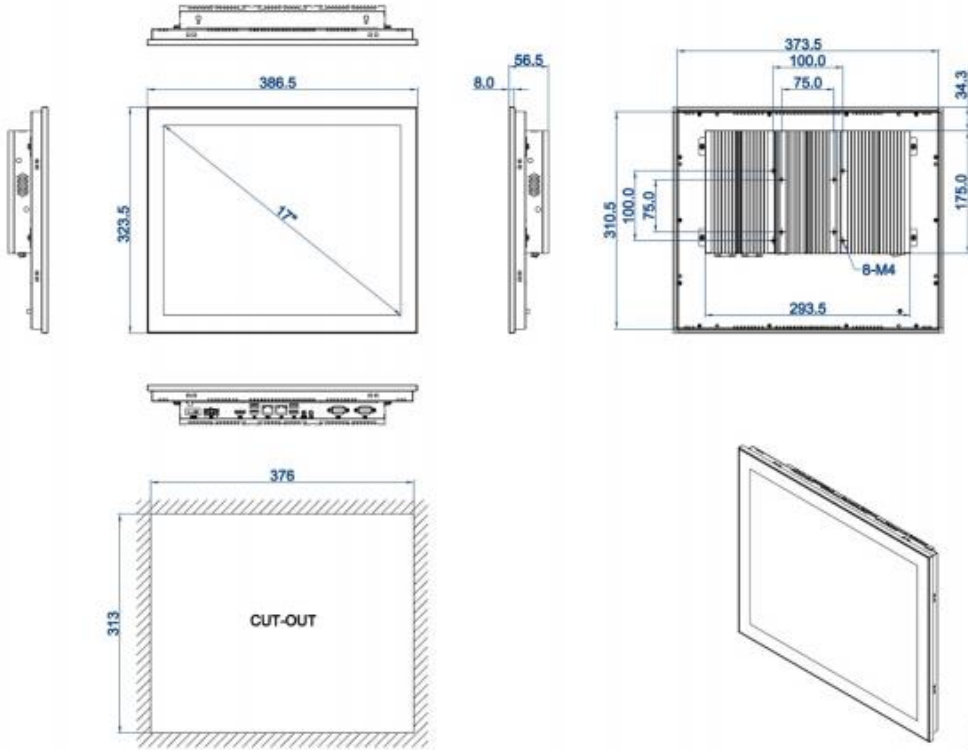

Options

Stockage	SSD
Communications	Wifi / Bluetooth
Dalle	Full HD
Support	VESA 75 & 100

